

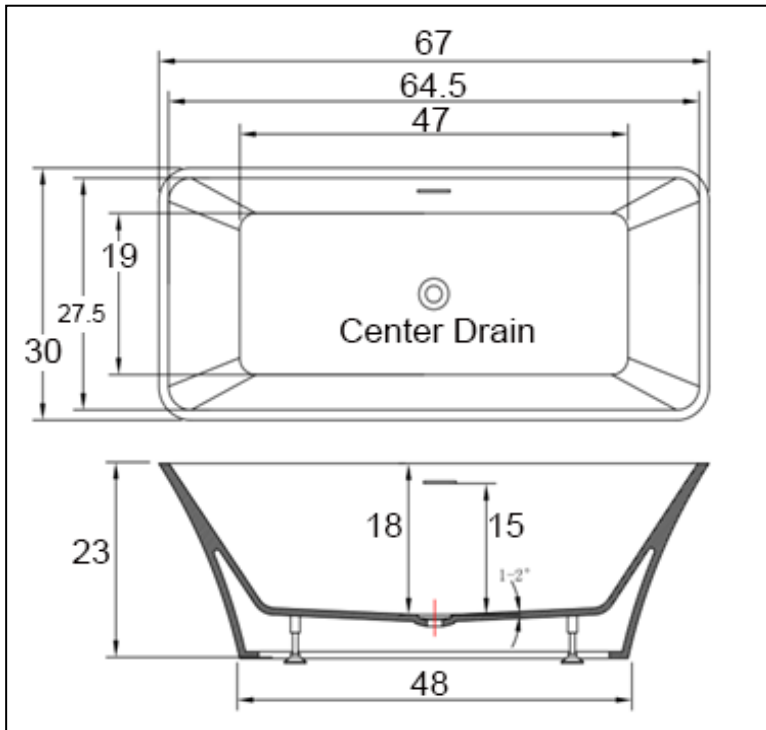

SanSiro Sandava-67-Air



Features	
Integrated Drain with Overflow	Yes
Slotted Overflow	Yes
Pop-up Drain	Yes
Integrated Variable Speed Blower	0.5 HP
White Air Jets on Floor	12
Water Proof Remote Control Activation	Yes
GFCI Electrical Supply	110V/15 Amp
Gallons to Overflow with Bather	56
Tub Weight Empty lbs	119
Shipping Weight lbs	160
Shipping Dimensions	71 x 33 x 30

Meets or Exceeds

CSA B45.5/IAPMO Z124-2017
 ASME A112.18.1-2018/CSA B125.1-18
 MA Code Accepted

